



# **RUNDOWN NOSE ASSEMBLIES**

**OPERATORS HANDBOOK (PART NO. 34142)**

ISSUE 9

NORBAR TORQUE TOOLS LTD, Beaumont Road, Banbury, Oxfordshire, OX16 1XJ, UNITED KINGDOM

Tel : + 44 (0) 1295 270333, Fax : + 44 (0) 1295 753643

[www.norbar.com](http://www.norbar.com)

[enquiry@norbar.com](mailto:enquiry@norbar.com)

## CONTENTS

	<u>PAGE</u>
Model Numbers	3
Introduction	4
0.2 - 10 N.m, 1.8 - 88 lbf.ins Model No. 50185	6
Torque Rate Curve (0.7 mm Thick Washers) Model No. 50185	7
Torque Rate Curve (1.5 mm Thich Washers) Model No. 50185	8
2 - 12 N.m, 1.5 - 9 lbf.ft Model No. 50160	10
Torque Rate Curve Model No. 50160	11
10 - 100 N.m, 7.5 - 75 lbf.ft Model No. 50186	12
Torque Rate Curve Model No. 50186	13
10 - 100 N.m, 7.5 - 75 lbf.ft Model No. 50195	14
Torque Rate Curve Model No. 50195	15
100 - 700 N.m, 75 - 515 lbf.ft Model No. 51071	16
Torque Rate Curve Model 51071	17
Spare Washer Stacks	18

This page left intentionally blank.

**THIS OPERATORS HANDBOOK COVERS THE FOLLOWING NOSE  
ASSEMBLY MODEL NUMBERS**

<u>MODEL NO.</u>	<u>DESCRIPTION</u>	<u>SQ. DR</u>	<u>FOR USE WITH</u>
50185	0.2 - 10 N.m (1.8 - 88.5 lbf.ins)	1/4"	TWA 10
50160	2 - 12 N.m (1.5 - 9 lbf.ft)	1/4"	TWA 100
50186	10 - 100 N.m (7.5 - 75 lbf.ft)	1/2"	TWA 100
50195	10 - 100 N.m (7.5 - 75 lbf.ft)	1/2"	TWA 1000
51071	100 - 700 N.m (75 - 515 lbf.ft) (less bed)	3/4"	TWA 1000
50163	100 - 700 N.m (75 - 515 lbf.ft) (with bed)	3/4"	TWA 1000

## INTRODUCTION

The Norbar rundown nose assembly used in conjunction with the Torque Wrench Analyser (TWA) is designed to measure the torque output of power tools. This it does by simulating the working conditions of screwed or bolted joints.

Spring washers can be arranged in various serial/parallel combinations to represent the working conditions as seen by the tool, ie. joints of varying stiffness ('soft' or 'hard' pull up) and for a range of maximum torque outputs.

Stacks of spring washers are supplied to simulate soft pull-up joints over the range of the TWA and short bolt to simulate hard pull-up joints. By rearranging the stacks of washers intermediate pull-up conditions can be simulated.

Refer to BS 6268-1982 , ISO 6544-1981 or 5393-1981 for further details on torque rundown.

Note: *When testing tools which require a reaction point, the rundown nose assembly (51071) should be used in conjunction with the rundown fixture bed which allows the transducer to move along the bed towards the reaction point as torque is applied. Model number for bed including nose assembly is 50163. See page 5*

## EXPLODED VIEW OF FIXTURE ASSEMBLY

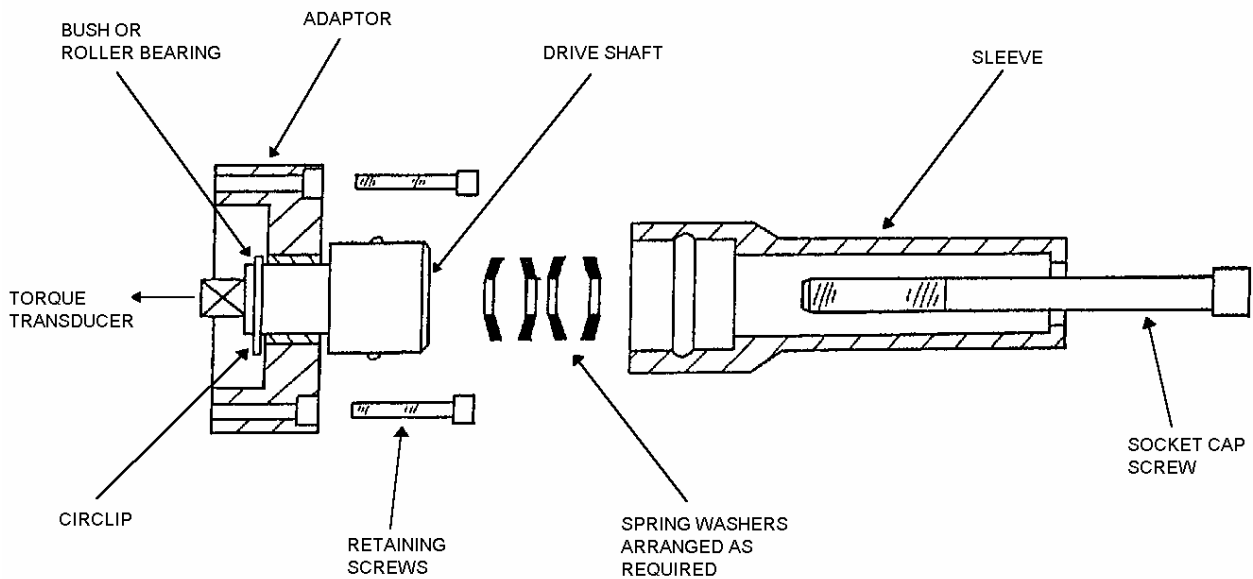

## RUNDOWN FIXTURE BED FOR 50163

When testing tools which require a reaction point, the rundown nose assembly must be used in conjunction with the rundown fixture bed which allows the transducer to move along the bed towards the reaction point as torque is applied.

The bed is necessary because as torque is applied, the length of the washer stack decreases thus the tool requires to move towards the transducer. Because the tools reaction point must be static due to friction, the transducer is mounted on a carriage which moves along grooves in the bed towards the tool as torque is applied.

A suitable reaction plate is bolted to the input end of the bed to take reaction from the tool under test.

Refer to BS 6268-1982, ISO 6544-1981 or 5393-1981 for further details on torque rundown.

### EXPLODED VIEW OF FIXTURE ASSEMBLY

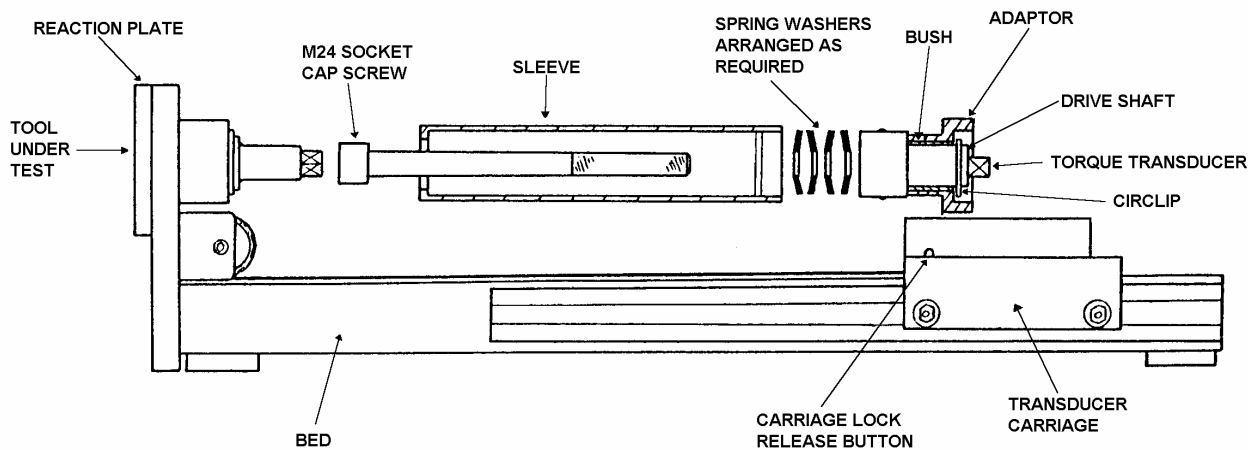

## 0.2 - 10 N.M, 1.8 - 88 LBF.INS MODEL NO. 50185

### FOR USE WITH TWA 10

Washer arrangements for joint simulation.

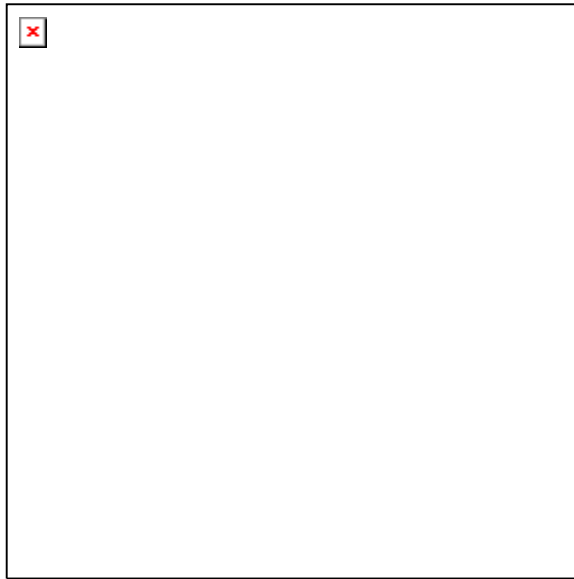

WASHERS IN  
PARALLEL

**WASHER  
MAKE UP  
FOR SOFT  
PULL-UP  
CONDITION** \_\_\_\_\_

WASHER  
MAKE UP



WASHERS IN  
SERIES

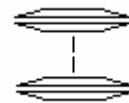

72 washers  
in series  
(Stack A)

0.2 - 0.7 N.m )  
1.8 - 6 lbf.ins ) 0.7 mm  
2 - 7 Kgf.cm ) Thick Washers  
)

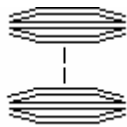

40 stacks of  
2 washers in  
parallel, in series  
(Stack B)

0.5 - 1.4 N.m )  
4.5 - 12.5 lbf.ins ) 0.7 mm  
5 - 14 Kgf.cm ) Thick Washers  
)

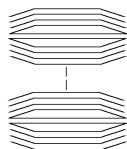

20 stacks of  
4 washers in  
parallel, in series  
(Stack C)

1.2 - 2.8 N.m )  
10 - 25 lbf.ins ) 0.7 mm  
12 - 28 Kgf.cm ) Thick Washers  
)

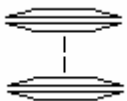

40 washers  
in series  
(Stack D)

2 - 6 N.m )  
20 - 50 lbf.ins ) 1.5 mm  
20 - 60 Kgf.cm ) Thick Washers  
)

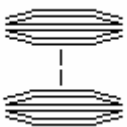

21 stacks of  
2 washers in  
parallel, in series  
(Stack E)

6 - 12 N.m )  
50 - 100 lbf.ins ) 1.5 mm  
60 - 120 Kgf.cm ) Thick Washers  
)

NOTE: *Exceeding maximum torque for washer make-up will result in permanent damage to washers.*

*Keep bolt and washers greased with a graphite loaded grease.*

*For a 'Hard' pull up condition, remove sleeve, long bolt and all spring washers. Fit short bolt and plain washer.*

*50185 supplied with washers stacks A, B, C, D and E.*

## **OPERATION PROCEDURE**

---

Switch TWA to 'memory' or 'memory auto reset' mode and select filter 'ON' or 'OFF' as required (see TWA Operators Handbook for details).

With selected arrangement of spring washers in fixture, run bolt down with tool and note torque output. Reverse tool to undo bolt ready for next test. Reset readout on TWA if in 'memory' mode.

## **0.2 - 10 N.M, 1.8 - 88 LBF.INS    MODEL NO. 50185**

### **GRAPHS SHOWING TORQUE RATE CURVES FOR VARIOUS WASHER MAKE-UPS**

---

BOLT SIZE:-            M6 x 80 mm long x 1.0 pitch, 12.9 socket cap screw, 5 mm A/F.

WASHERS:-            DIN 2093 - A12.5 GRI (12.5 mm x 6.2 mm x 0.7 mm)  
and DIN 6796-6-FSX (14 mm x 6.4 mm x 1.5 mm).

LUBRICATION:-        Rocol M204 G Graphite Grease or Rocol Tufgear 85.

### **CURVES FOR 0.7 MM THICK WASHER STACKS**

---



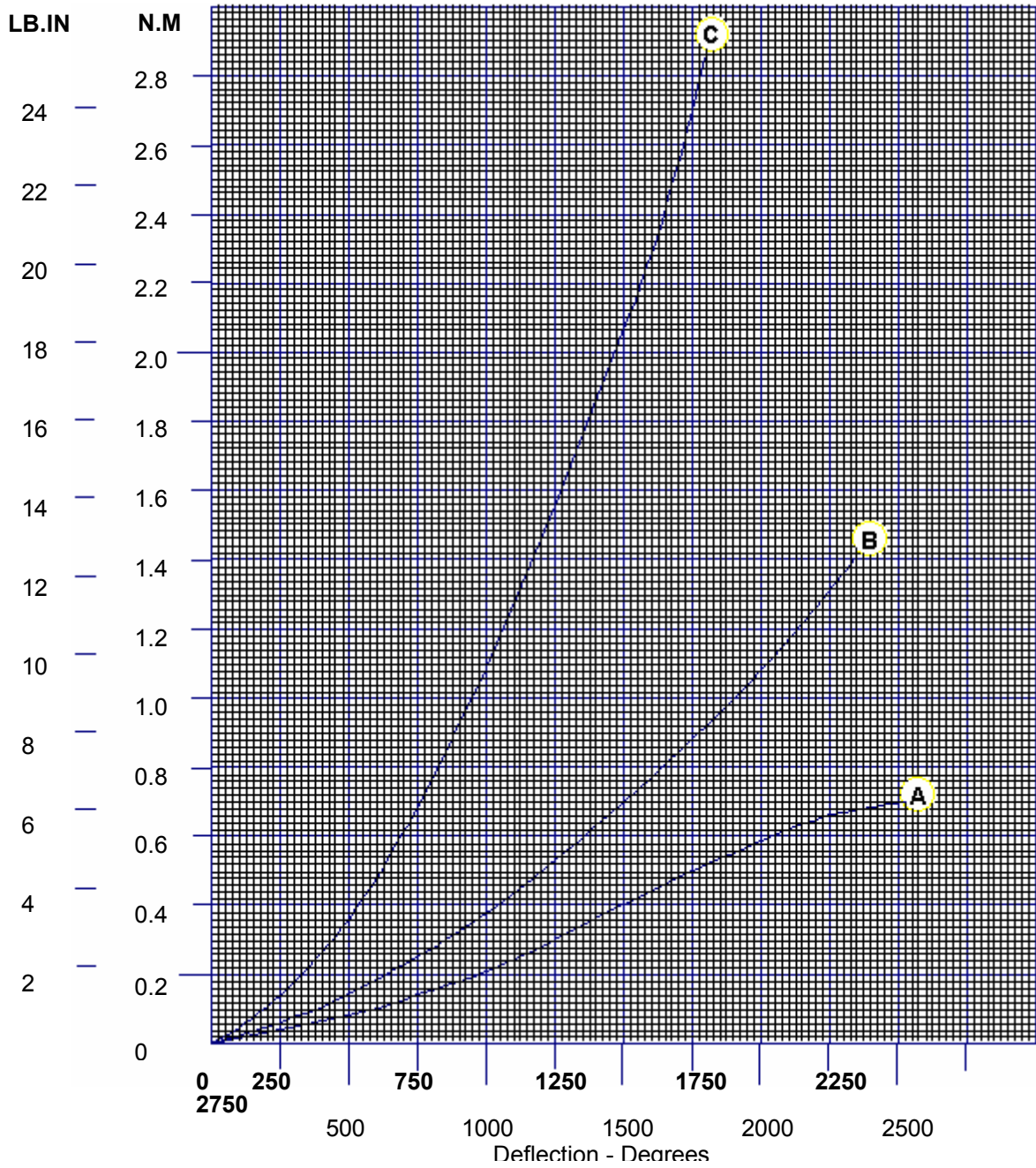

## 0.2 - 10 N.M, 1.8 - 88 LBF.INS MODEL NO. 50185

### CURVES FOR 1.5 MM THICK WASHER STACKS

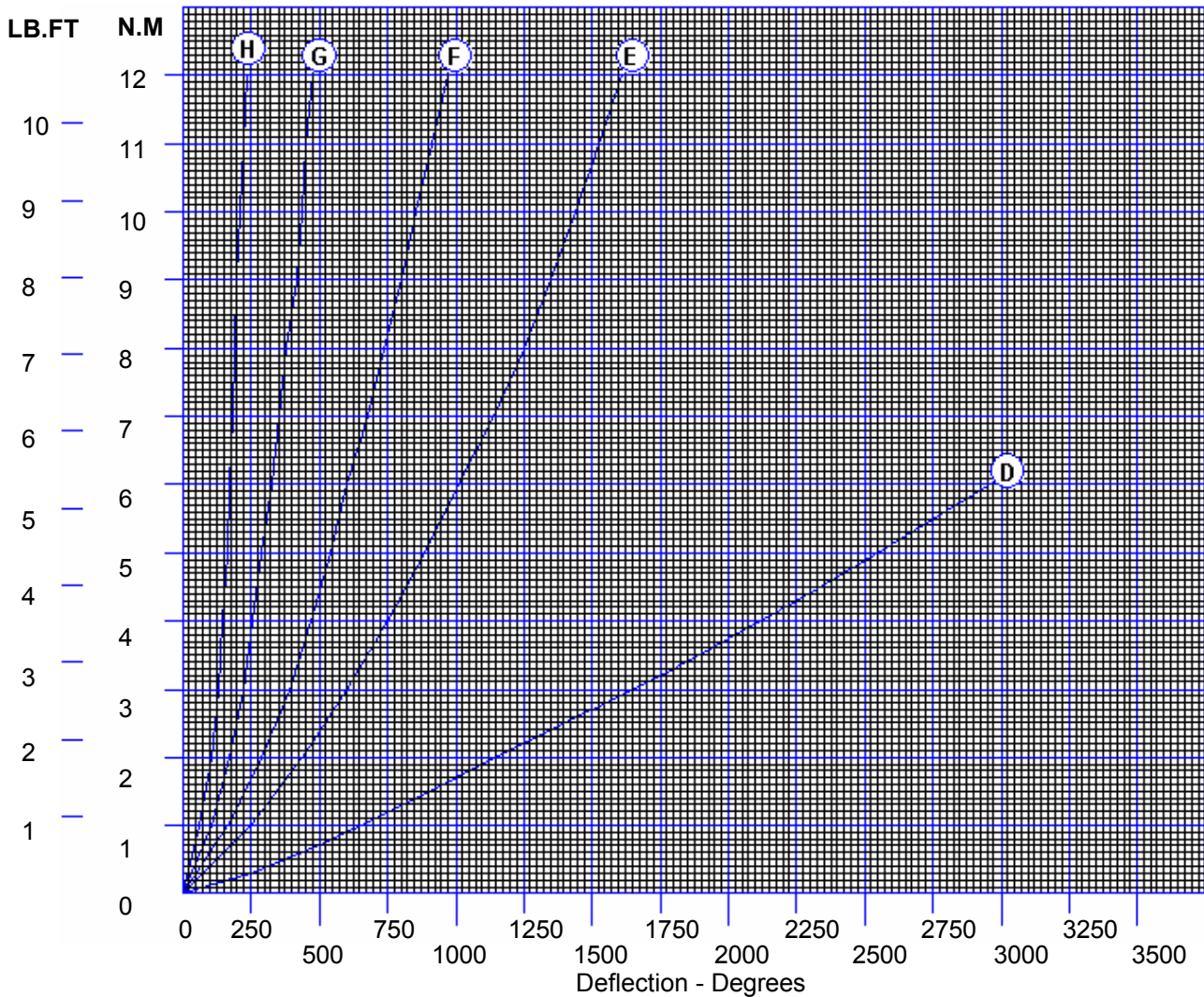

STACK	WASHER THICKNESS (mm)	WASHER MAKE-UP
'A'	0.7	72 Washers in series
'B'	0.7	40 Stacks of 2 washers in parallel, in series
'C'	0.7	20 Stacks of 4 washers in parallel, in series
'D'	1.5	40 Washers in series
'E'	1.5	21 Stacks of 2 washers in parallel, in series
'F'	1.5	14 Stacks of 3 washers in parallel, in series
'G'	1.5	7 Stacks of 6 washers in parallel, in series
'H'	1.5	42 Washers in parallel

NOTE: Washer make-ups 'A', 'B', 'C', 'D' and 'E' only for soft pull up condition. 'F', 'G' and 'H' for intermediate pull up condition.

This page left intentionally blank.

## 2 - 12 N.M, 1.5 - 9 LBF.FT    MODEL NO. 50160

### FOR USE WITH TWA 100

Washer arrangements for joint simulation.



WASHERS IN  
 SERIES

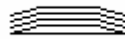

WASHERS IN  
 PARALLEL

### WASHER MAKE-UP FOR SOFT PULL-UP CONDITION \_\_\_\_\_

WASHER MAKE-UP

TORQUE RANGE

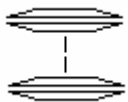

40 Washers  
 in series  
 (Stack D)

2 - 6 N.m  
 1.5 - 4.5 lbf.ft  
 20 - 50 lbf.ins  
 20 - 60 Kgf.cm

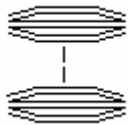

21 Stacks of  
 2 washers in  
 parallel, in series  
 (Stack E)

6 - 12 N.m  
 4.5 - 9 lbf.ft  
 50 - 100 lbf.ins  
 60 - 120 Kgf.cm

NOTE:    *Exceeding maximum torque for washer make-up will result in permanent damage to washers.  
 Keep bolt and washers greased with a graphite loaded grease.  
 For a 'hard' pull up condition, remove sleeve, long bolt and all spring washers. Fit short bolt and plain washers.  
 50160 supplied with washer stacks D and E.*

### OPERATION PROCEDURE \_\_\_\_\_

Switch TWA to 'memory' or 'memory auto reset' mode and select filter 'ON' or 'OFF' as required (see TWA Operators Handbook for details).

With selected arrangement of spring washers in fixture, run bolt down with tool and note torque output. Reverse tool to undo bolt ready for next test. Reset readout on TWA if in 'memory' mode.

## 2 - 12 N.M, 1.5 - 9 LBF.FT MODEL NO. 50160

### GRAPHS SHOWING TORQUE RATE CURVES FOR VARIOUS WASHER MAKE-UPS \_\_\_\_\_

BOLT SIZE:- M6 x 80 mm long x 1.0 mm pitch, 12.9 socket cap screw, 5 mm A/F  
 WASHERS:- DIN 6796-6-FST (14 mm x 6.4 mm x 1.5 mm)  
 LUBRICATION:- Rocol M204 G Graphite Grease or Rocol Tufgear 85.

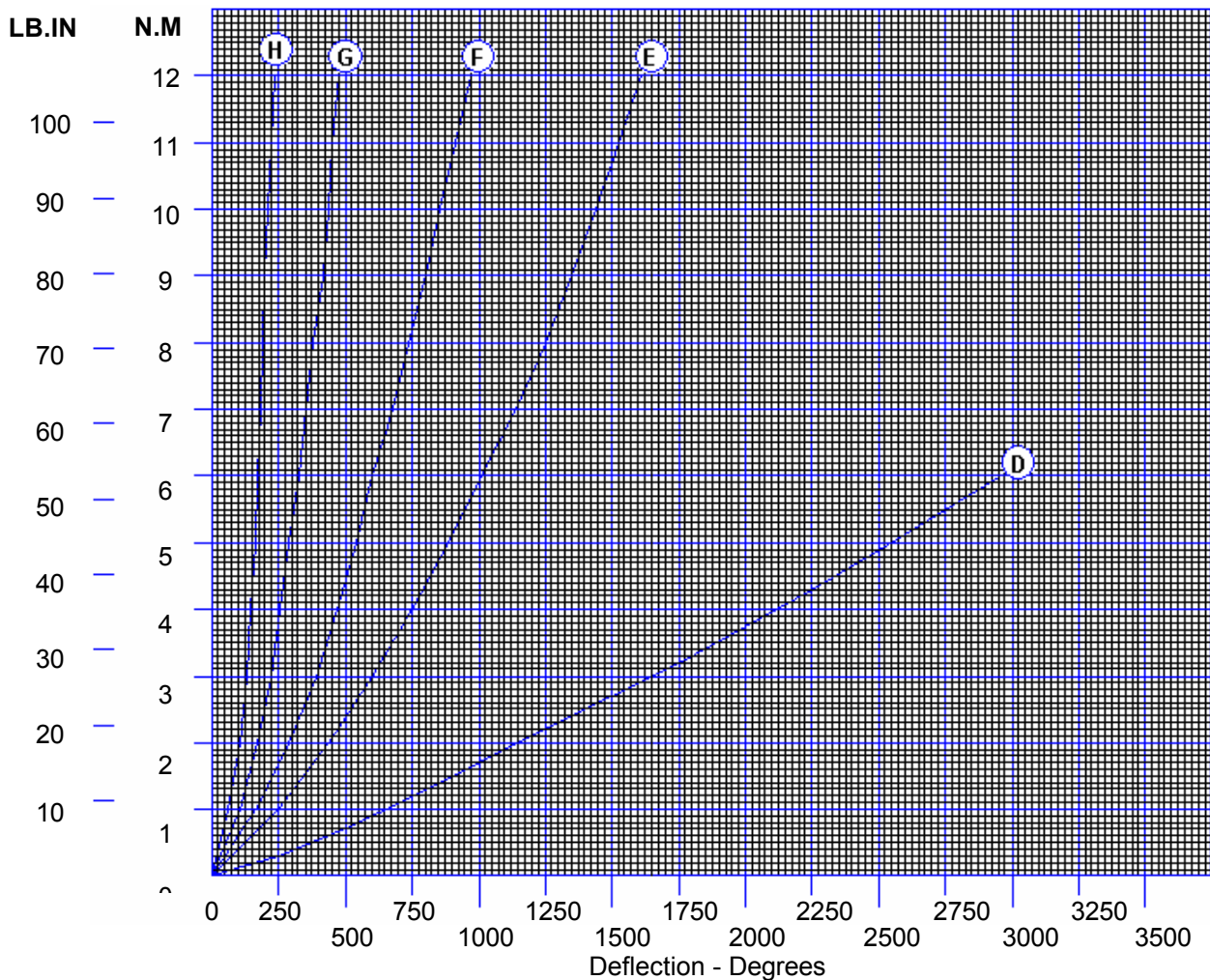

STACK

'D'  
'E'  
'F'  
'G'  
'H'

WASHER MAKE-UP

40 Washers in series  
 21 Stacks of 2 washers in parallel, in series  
 14 Stacks of 3 washers in parallel, in series  
 7 Stacks of 6 washers in parallel, in series  
 42 Washers in parallel

NOTE: Washer make-ups 'D' and 'E' only for soft pull-up condition. 'F', 'G' and 'H' for intermediate pull-up condition.

## 10 - 100 N.M, 7.5 - 75 LBF.FT    MODEL NO. 50186

### FOR USE WITH TWA 100

Washer arrangements for joint simulation.

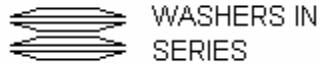

WASHERS IN SERIES

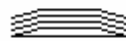

WASHERS IN PARALLEL

### WASHER MAKE UP FOR SOFT PULL-UP CONDITION ---

WASHER MAKE UP

TORQUE RANGE

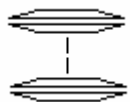

28 Washers  
in series  
(Stack F)

10 - 50 N.m  
 7.5 - 37 lbf.ft  
 90 - 450 lbf.ins  
 100 - 500 Kgf.cm

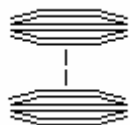

15 Stacks of  
2 washers in  
parallel, in series  
(Stack G)

30 - 100 N.m  
 22 - 75 lbf.ft  
 270 - 900 lbf.ins  
 300 - 1000 Kgf.cm

NOTE:    *Exceeding maximum torque for washer make-up will result in permanent damage to washers.*  
           *Keep bolt and washers greased with a graphite loaded grease.*  
           *For a 'hard' pull up condition, remove sleeve, long bolt and all spring washers. Fit short bolt and plain washer.*  
           *50186 supplied with washer stacks F and G.*

### OPERATION PROCEDURE ---

Switch TWA to 'memory' or 'memory auto reset' mode and select filter 'ON' or 'OFF' as required (see TWA Operators Handbook for details).

With selected arrangement of spring washers in fixture, run bolt down with tool and note torque output. Reverse tool to undo bolt ready for next test. Reset readout on TWA if in 'memory' mode.

## 10 - 100 N.M, 7.5 - 75 LBF.FT MODEL NO. 50186

### GRAPHS SHOWING TORQUE RATE CURVES FOR VARIOUS WASHER MAKE-UPS \_\_\_\_\_

BOLT SIZE:- M 12 x 120 mm long x 1.25 mm pitch, 12.9 socket cap screw, 10 mm A/F.

WASHERS:- DIN 6796-12-FST (29 mm x 13 mm x 3 mm)

LUBRICATION:- Rocol M204 G Graphite Grease or Rocol Tufgear 85.

**LB.IN N.M**

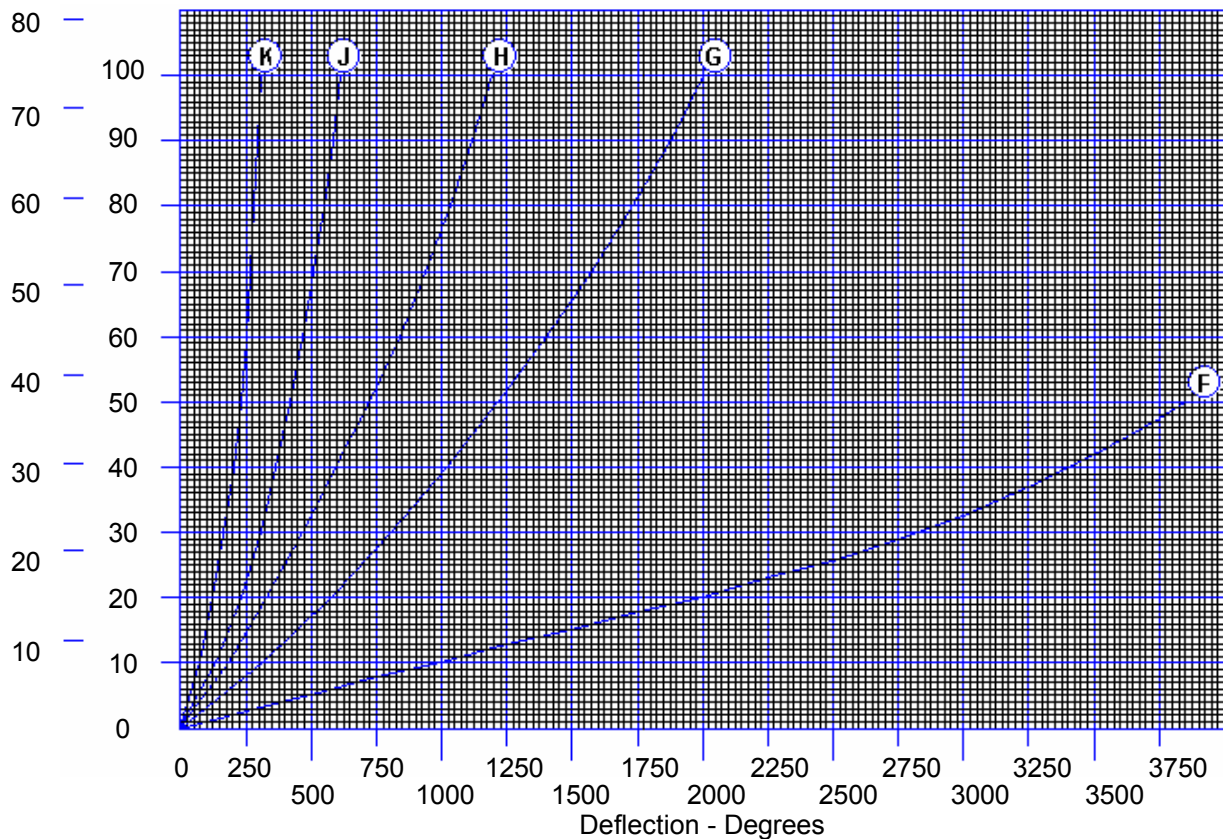

STACK

WASHER MAKE-UP

- 'F' 28 Washers in series
- 'G' 15 Stacks of 2 washers in parallel, in series
- 'H' 10 Stacks of 3 washers in parallel, in series
- 'J' 6 Stacks of 5 washers in parallel, in series
- 'K' 30 Washers in parallel

NOTE: Washer make-ups 'F' and 'G' only for soft pull-up condition. 'H', 'J' and 'K' for intermediate pull-up condition.

**10 - 100 N.M, 7.5 - 75 LBF.FT MODEL NO. 50195**

**FOR USE WITH TWA 1000**

Washer arrangements for joint simulation.



WASHERS IN SERIES

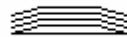

WASHERS IN PARALLEL

**WASHER MAKE-UP FOR SOFT PULL-UP CONDITION** \_\_\_\_\_

WASHER MAKE-UP

TORQUE RANGE

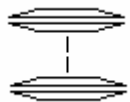

28 Washers  
 in series  
 (Stack F)

10 - 50 N.m  
 7.5 - 37 lbf.ft  
 90 - 450 lbf.in  
 100 - 500 Kgf.cm

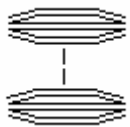

15 Stacks of  
 2 Washers in  
 Parallel, in series  
 (Stack G)

30 - 100 N.m  
 22 - 75 lbf.ft  
 270 - 900 lbf.in  
 300 - 1000 Kgf.cm

NOTE: *Exceeding maximum torque for washer make-up will result in permanent damage to washers.  
 Keep bolt and washers greased with a graphite loaded grease.  
 For a 'Hard' pull up condition, remove sleeve, long bolt and all spring washers. Fit short bolt and plain washer.  
 50195 supplied with washer stacks F and G.*

**OPERATION PROCEDURE** \_\_\_\_\_

Switch TWA to 'memory' or 'memory auto reset' mode and select filter 'ON' or 'OFF' as required (see TWA Operators Handbook for details).

With selected arrangement of spring washers in fixture, run bolt down with tool and note torque output. Reverse tool to undo bolt ready for next test. Reset readout on TWA if in 'memory' mode.



## 10 - 100 N.M, 7.5 - 75 LBF.FT MODEL NO. 50195

### GRAPHS SHOWING TORQUE RATE CURVES FOR VARIOUS WASHER MAKE-UPS \_\_\_\_\_

BOLT SIZE:- M12 x 120 mm long x 1.25 mm pitch, 12.9 socket cap screw, 10 mm A/F

WASHERS:- DIN 6796-12-FST (29 mm x 13 mm x 3 mm)

LUBRICATION:- Rocol M204 G Graphite Grease or Rocol Tufgear 85.

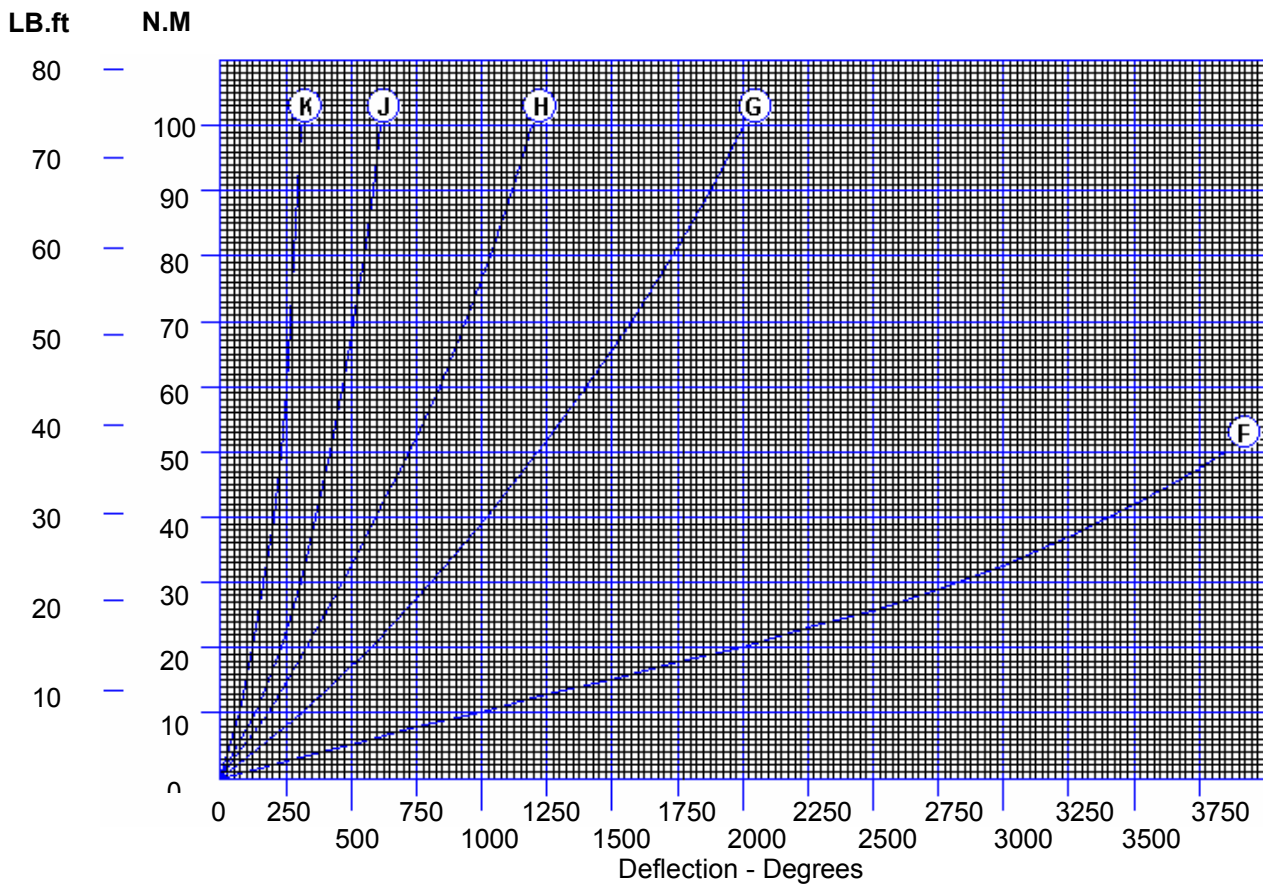

STACK

WASHER MAKE-UP

- 'F' 28 Washers in series
- 'G' 15 Stacks of 2 washers in parallel, in series
- 'H' 10 Stacks of 3 washers in parallel, in series
- 'J' 6 Stacks of 5 washers in parallel, in series
- 'K' 30 Washers in parallel

NOTE: Washer make-ups 'F' and 'G' only for soft pull-up condition. 'H', 'J' and 'K' for intermediate pull-up condition.

**100 - 700 N.M, 75 - 515 LBF.FT MODEL NO.S 51071, 50163**

**FOR USE WITH TWA 1000**

Washer arrangements for joint simulation.



WASHERS IN SERIES

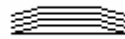

WASHERS IN PARALLEL

**WASHER MAKE-UP FOR SOFT PULL-UP CONDITION**

---

WASHER MAKE-UP

TORQUE RANGE

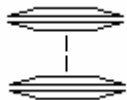

30 Washers  
 in series  
 (Stack A)

100 - 400 N.m  
 74 - 300 lbf.ft  
 1000 - 4000 Kgf.cm

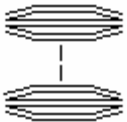

15 Stacks of  
 2 Washers in  
 parallel, in series  
 (Stack B)

350 - 700 N.m  
 260 - 515 lbf.ft  
 3500 - 7000 Kgf.cm

NOTE: *Exceeding maximum torque for washer make-up will result in permanent damage to washers.*

*Keep bolt and washers greased with a graphite loaded grease.*

*For a 'hard' pull up condition, remove sleeve, long bolt and all spring washers. Fit short bolt and plain washer*

*50163 and 51071 supplied with washer stack B.*

**OPERATION PROCEDURE**

---

Switch TWA to 'memory' or 'memory auto Reset' mode and select filter 'ON' or 'OFF' as required (see TWA Operators Handbook for details).

With selected arrangement of spring washers in fixture, run bolt down with tool and note torque output. Reverse tool to undo bolt ready for next test. Reset readout on TWA if in 'memory' mode.

## 100 - 700 N.M, 75 - 515 LBF.FT MODEL NO.S 51071, 50163

### GRAPHS SHOWING TORQUE RATE CURVES FOR VARIOUS WASHER MAKE-UPS \_\_\_\_\_

BOLT SIZE:- M 24 x 240 mm long x 3 mm pitch, 12.9 socket cap screw

WASHERS:- DIN 6796-24-FST (56 mm x 25 mm x 6 mm)

LUBRICATION:- Rocol M204 G Graphite Grease or Rocol Tufgear 85.

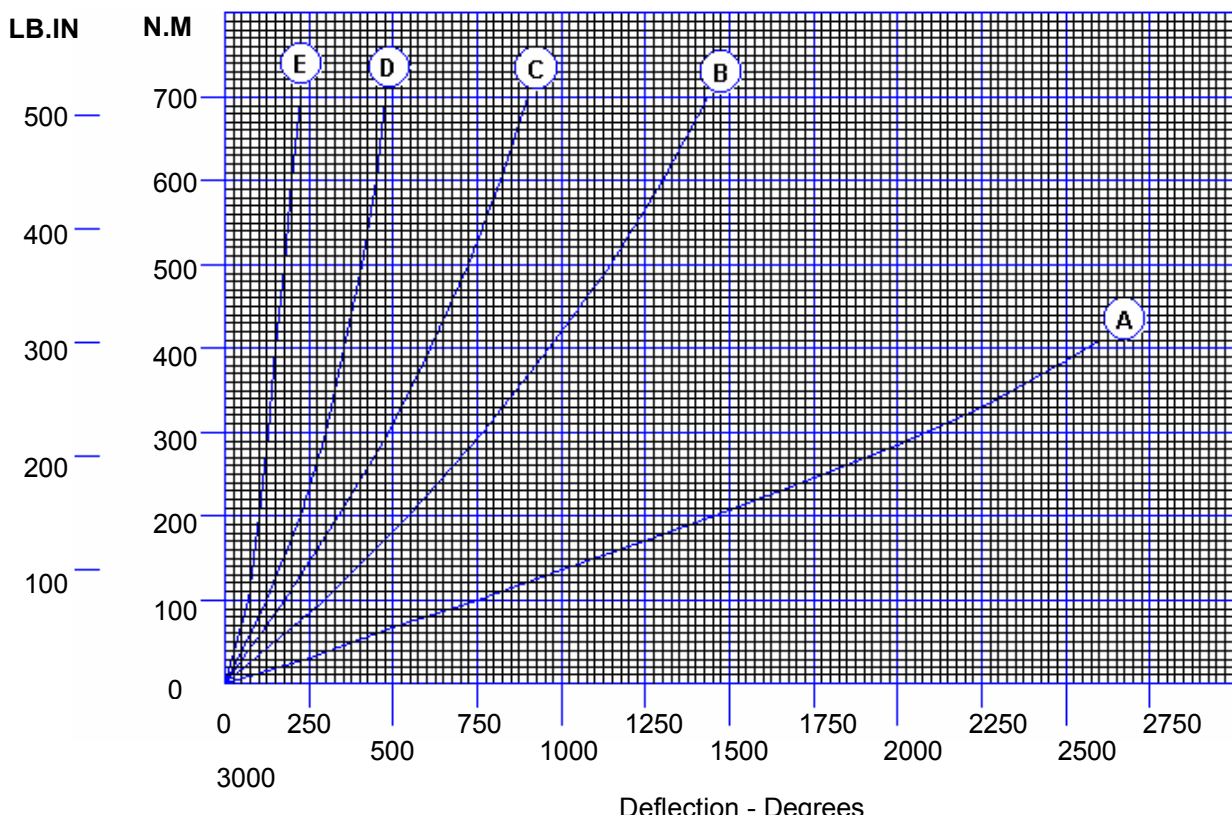

STACK

- 'A'
- 'B'
- 'C'
- 'D'
- 'E'

WASHER MAKE-UP

- 30 Washers in series
- 15 Stacks of 2 washers in parallel, in series
- 10 Stacks of 3 washers in parallel, in series
- 6 Stacks of 5 washers in parallel, in series
- 30 Washers in parallel

NOTE: Washer make-ups 'A' and 'B' only for soft pull-up condition. 'C', 'D' and 'E' for intermediate pull-up condition.

## SPARE WASHER STACKS

PART NO.	CAPACITY	FOR USE WITH RUNDOWN NOSE ASSEMBLY	TWA
50175 (Washer Stack A)	0.2 - 0.7 N.m	50185	10
50176 (Washer Stack B)	0.5 - 1.4 N.m	50185	10
50177 (Washer Stack C)	1.2 - 2.8 N.m	50185	10
50178 (Washer Stack D)	2 - 6 N.m	50185/50160	10
50179 (Washer Stack E)	6 - 12 N.m	50185/50160	10
50180 (Washer Stack F)	10 - 50 N.m	50186/50195	100
50192 (Washer Stack G)	30-100 N.m	50186/50195	100